

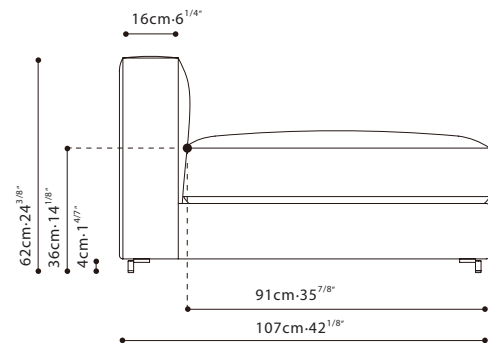

EPIC / FRAME: Solid birch wood frame, covered in polyurethane foam and fabric lining over woven plastic webbing. Armrest constructed in solid wood, and in some cases covered in Eco-leather. **CUSHION:** Seat cushion in high resilient foam and feather-down. Back cushion in feather-down and polyester, with option to add back bolster for added support. Throw cushion C08H0205 filled with feather-down and polyester fiber. Sofa covers removable in fabric. **UPHOLSTERY:** Sofa elements available in fabric or leather. **SOFA ARM:** B12H0211 and B12H0212 serve as both left or right arm, available in fabric or leather. Wood armrest (B12H0213/B12H0214/B12H0215) available in Grey Oak wrapped in Eco-leather. All pieces come with in-set metal base, equipped with connectors.



FABRIC VERSION

C01H0201

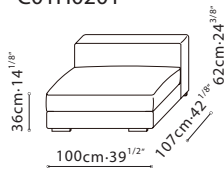

C01H0202

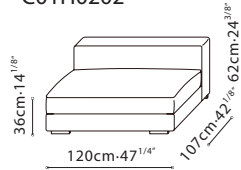

C01H0203

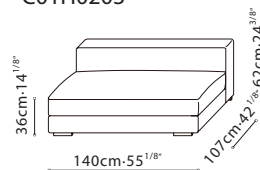

C01H0204

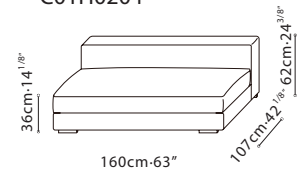

C01H0205

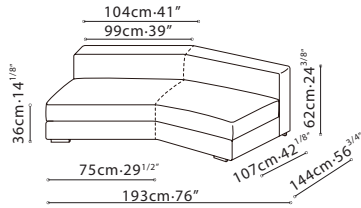

C01H0206+B12H0214

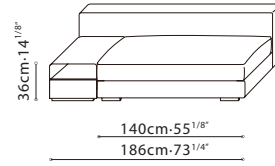

C01H0207+B12H0214

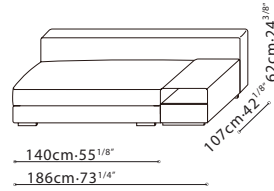

*Drawer Unit comes in Grey Oak with FU-02 Black, FU-03 Dusk or FU-05 Hazelwood

C01H0208+B12H0214

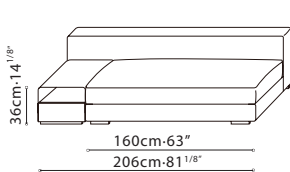

C01H0209+B12H0214

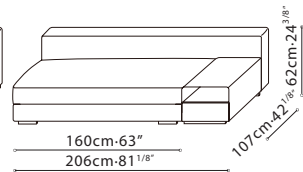

*Drawer Unit comes in Grey Oak with FU-02 Black, FU-03 Dusk or FU-05 Hazelwood

C01H0210

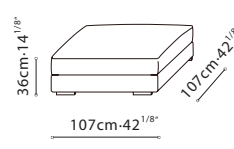

B12H0211

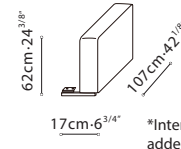

*Interchangeable armrest, can be added to either side

B12H0212

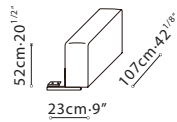

*Interchangeable armrest, can be added to either side

B12H0213

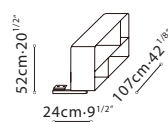

*This unit comes in Grey Oak with exterior wrapping available in: FU-02 Black, FU-03 Dusk, or FU-05 Hazelwood
*Interchangeable armrest, can be added to either side

B12H0214

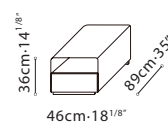

*Built in Wireless Charging, requires an US Wall Adapter
*Drawer Unit comes in Grey Oak with FU-02 Black, FU-03 Dusk or FU-05 Hazelwood
*Suitable for C01H0206, C01H0207, C01H0208 and C01H0209 only

B12H0215

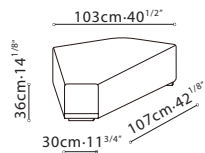

*Drawer Unit comes in Grey Oak with FU-02 Black, FU-03 Dusk or FU-05 Hazelwood

C08H0201

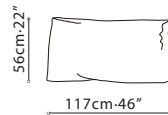

C08H0202



C08H0203

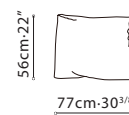

C08H0204



C08H0205



C08H0206

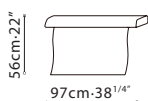

*Optional bolster for C08H0201

C08H0207

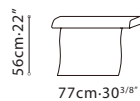

*Optional bolster for C08H0202

C08H0208

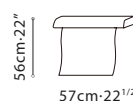

*Optional bolster for C08H0203

LEATHER VERSION

C01H0201.

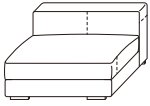

C01H0202.

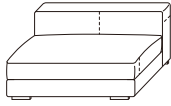

C01H0203.

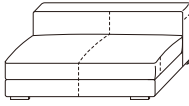

C01H0204.

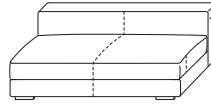

C01H0205.

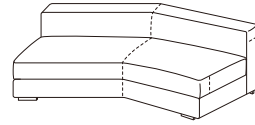

C01H0206.

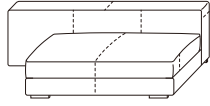

C01H0207.

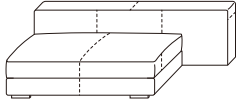

C01H0208.

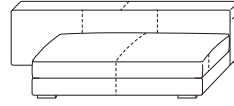

C01H0209.

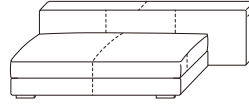

C01H0210.

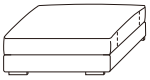

B12H0211.



B12H0212.



B12H0213.



B12H0214.



B12H0215.

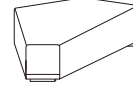

C08H0201.



C08H0202.



C08H0203.



C08H0204.



C08H0205.



C08H0206.

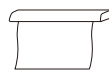

C08H0207.



C08H0208.



(dotted lines illustrate positioning of stitched seams on leather versions of this sofa)