

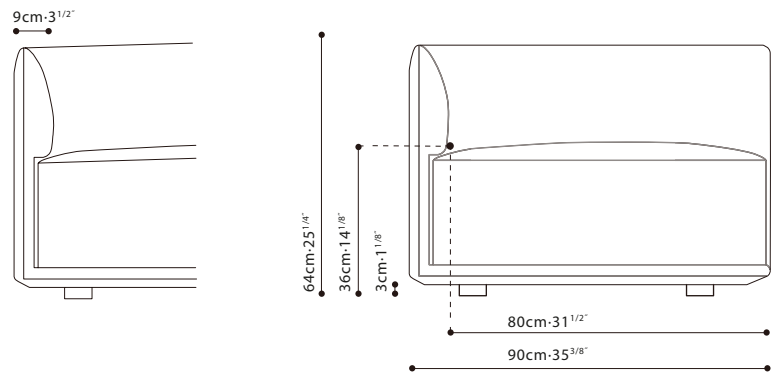

**ELAN-NEW/** FRAME: Seat, backrest, and armrest constructed on a steel frame. The seat frame is paired with cross-woven elastic webbing. The frame is covered with polyurethane foam and fabric lining. Optional storage unit, unique to the Elan collection, is produced with wood and FU Eco Leather. SEAT: Seat cushions consists of solid birch bases, equipped with sinuous springs and high-resilient polyurethane foam topped with polyester fiber. CUSHIONS: Back cushions consists of channeled feather down and polyester fiber padding with high-resilient polyurethane foam center insert. Throw cushion C81F0204 is filled with feather down and polyester fiber, while C81F0205 is filled with feather down only. All cushions have hidden zipper closing. LEGS: Inset black plastic (ABS) legs giving the sofa a floating visual effect. UPHOLSTERY: all Fabric (removable), all Leather (non-removable), or Fabric + Leather combination.



## FABRIC VERSION

C01F0201

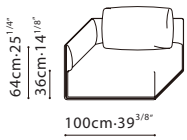

C01F0202

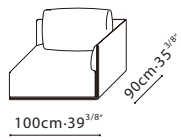

C01F0203

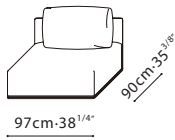

C01F0204

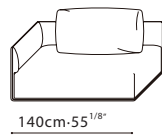

C01F0205

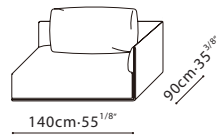

C01F0219

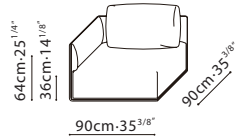

C01F0206

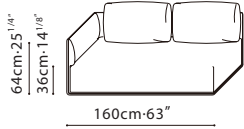

C01F0207

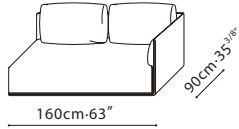

C01F0208

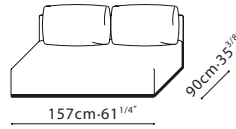

C01F0209 + C07F0216

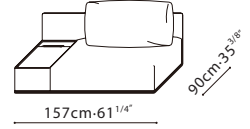
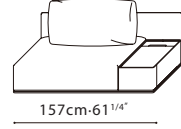
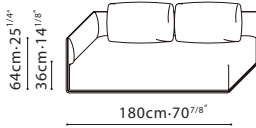
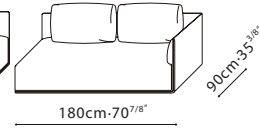

Table component can be used on either sides  
\*Drawer Unit comes in Grey Oak with FU-02 Black or FU-03 Taupe

C01F0210



C01F0211



C01F0212 + C07F0216

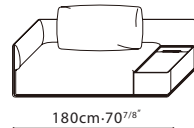

C01F0213 + C07F0216

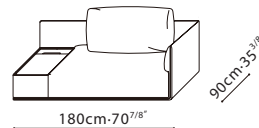

C07F0216

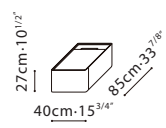

\*Drawer Unit comes in Grey Oak with FU-02 Black or FU-03 Taupe

C01F0214

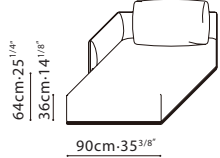

C01F0215

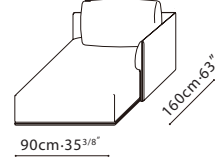

C01F0217

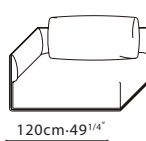

C01F0218

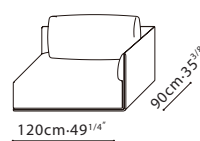

C81F0204

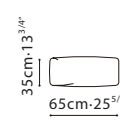

C81F0204

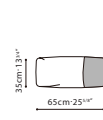

C81F0205

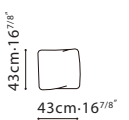

\*The shadow part is leather, the rest is fabric

## LEATHER VERSION

C01F0201

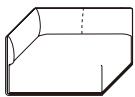

C01F0202

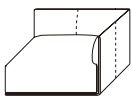

C01F0203

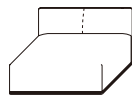

C01F0204

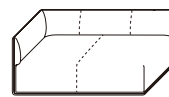

C01F0205

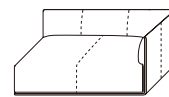

C01F0206

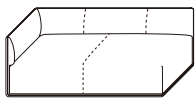

C01F0207

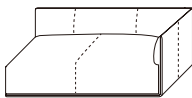

C01F0208

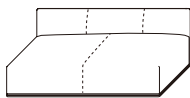

C01F0209 + C07F0216

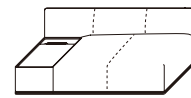
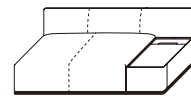

C01F0210

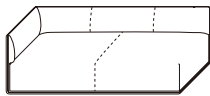

C01F0211

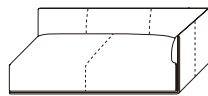

C01F0212 + C07F0216

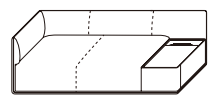

C01F0213 + C07F0216

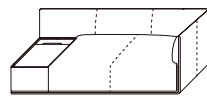

C07F0216



C01F0214

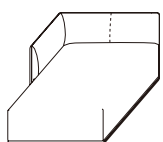

C01F0215

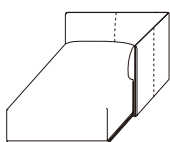

C01F0217

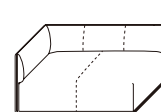

C01F0218

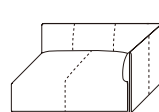

C81F0204



C81F0204



C81F0205



(dotted lines illustrate positioning of stitched seams on leather versions of this sofa)

# SAMPLE CONFIGURATION

