

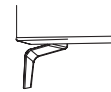

**ALISON /** FRAME: Arms & back constructed of solid Birch ,covered w/fabric lined polyurethane foam. SEAT: Steel seat frame paired w/cross-woven elastic webbing & sinuous springs supporting seat cushions consisting of high-resilient polyurethane foam wrapped in feather down. CUSHIONS: Feather down filled back cushions w/high-resilient polyurethane foam core. Feather down filled toss pillows BASE: Chrome plated or black painted die-cast steel; both w/plastic glides. UPHOLSTERY: Fabric (removable) or leather

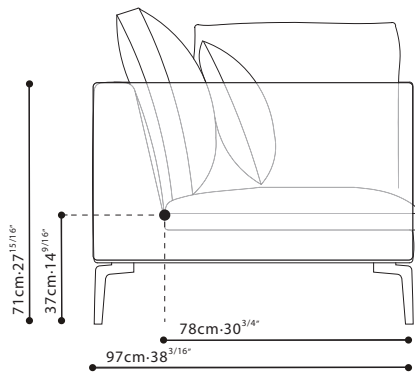

ALISON PLUS  
Blackened Steel

## FABRIC VERSION

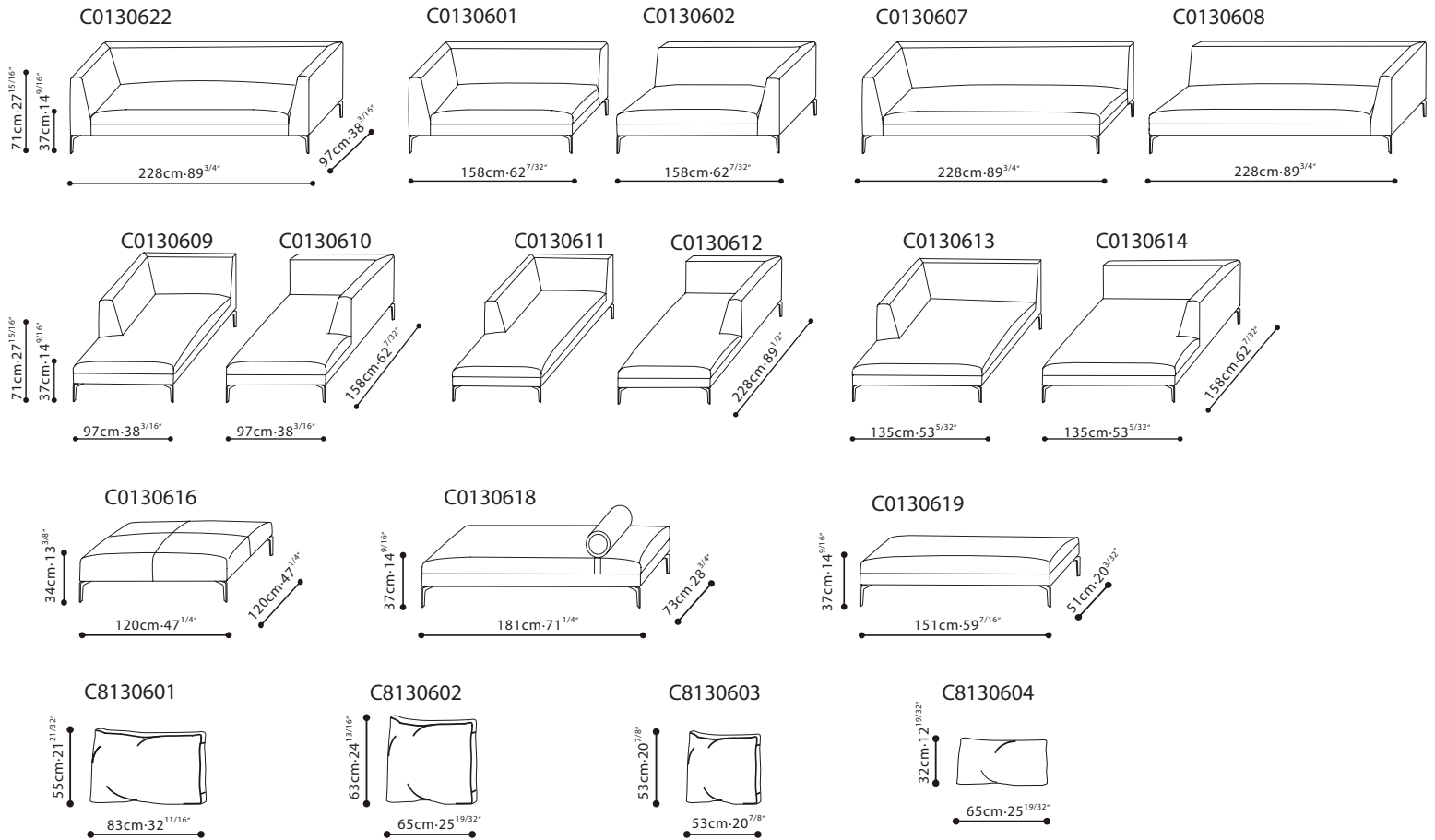

## LEATHER VERSION

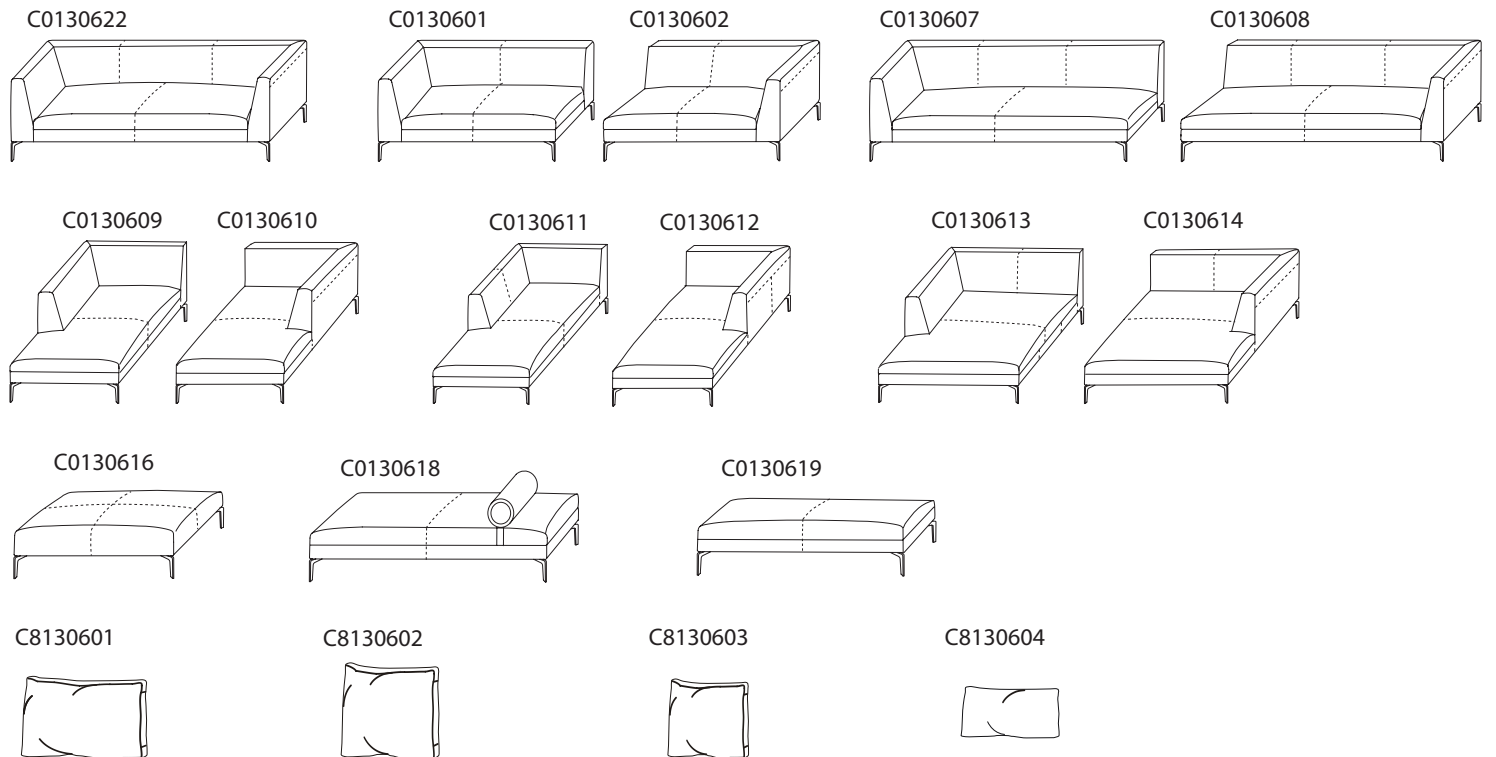

(dotted lines illustrate positioning of stitched seams on leather versions of this sofa)

## RECOMMENDED CUSHIONS

Item Code	Recommended Cushions
C0130601	C8130601*1, C8130602*1, and C8130603*1
C0130602	C8130601*1, C8130602*1, and C8130603*1
C0130607	C8130601*2, C8130603*1, and C8130604*1
C0130608	C8130601*2, C8130603*1, and C8130604*1
C0130609	C8130601*1, and C8130603*1
C0130610	C8130601*1, and C8130603*1
C0130611	C8130601*1, and C8130603*1
C0130612	C8130601*1, and C8130603*1
C0130613	C8130601*1, C8130602*1, and C8130603*1
C0130614	C8130601*1, C8130602*1, and C8130603*1
C0130616	NONE
C0130618	NONE
C0130619	NONE
C0130622	C8130601*2, and C8130603*2

## SAMPLE CONFIGURATION

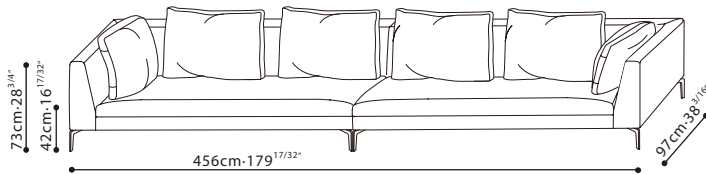

C0130607+C8130601×2+C8130603+C0130608+C8130601×2+C8130603

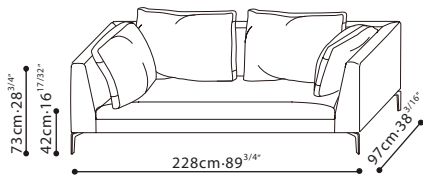

C0130622+C8130601×2+C8130603×2

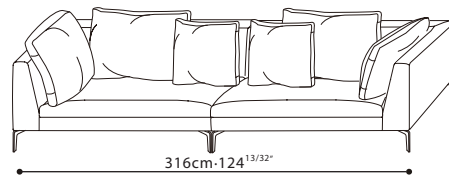

C0130601+C8130601+C8130602+C8130603+C0130602  
+C8130601+C8130602 +C8130603

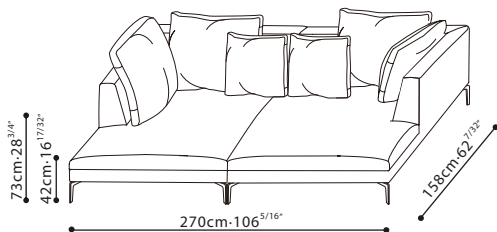

C0130613+C8130601+C8130602+C8130603  
+C0130614+C8130601+C8130602+C8130603

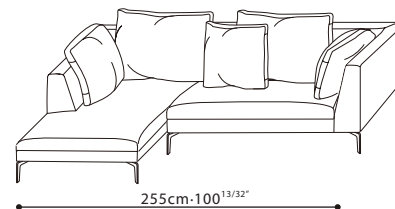

C0130609+C8130601+C8130603+C0130602  
+C8130601+C8130602+C81306013

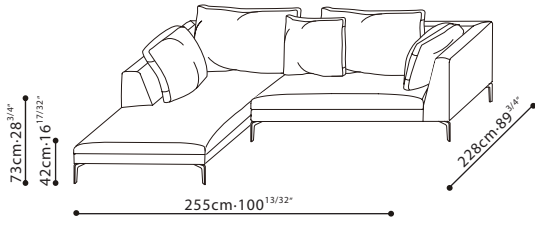

C0130611+C8130601+C8130603+C0130602  
+C8130601+C8130602+C8130603

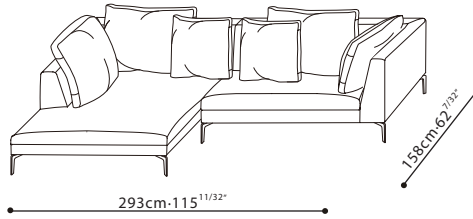

C0130613+C8130601+C8130602+C8130603  
+C0130602+C8130601+C8130602+C8130603

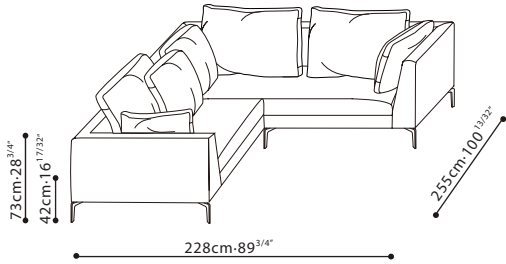

C0130601+C8130601+C8130602+C8130603  
+C0130622+C8130601×2+C8130603×2

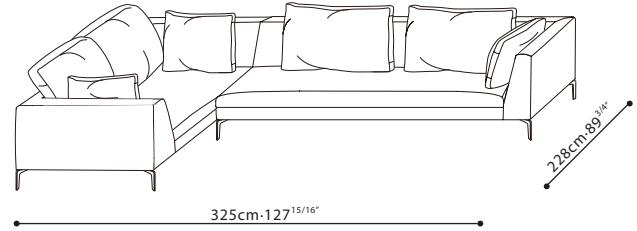

C0130622+C8130601×2+C8130603×2+C0130608  
+C8130601×2+C8130603

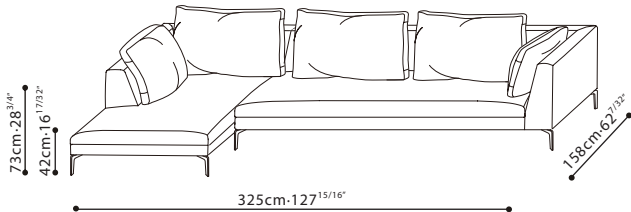

C0130609+C8130601+C8130603+C0130608  
+C8130601×2+C8130603

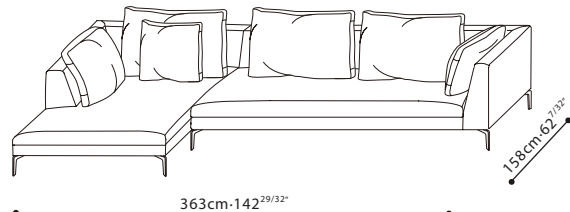

C0130613+C8130601+C8130602+C8130603  
+C0130608+C8130601×2+C8130603

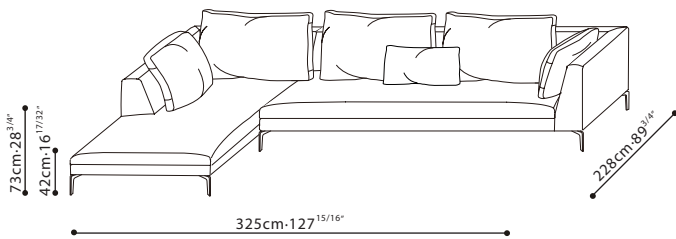

C0130611+C8130601+C8130603+C0130608  
+C8130601×2+C8130603+C8130604